



POLYVALLEY
makes life easier

POLY VALLEY TECHNOLOG (TIANJIN) CO.,LTD.

Professional polycarbonate sheets manufacturer

ENERGY-SAVING AND ENVIRONMENTALLY
FRIENDLY MATERIALS MAKE LIFE EASIER

PART 01

About us

Professional Polycarbonate sheets manufacturer



Company

About us

Polyvalley Technology (Tianjin) Co.,Ltd. is located in the Chinese Bohai Sea bay economic center Tianjin city and specializing in R&D, manufacturing and self-exporting of polycarbonate sheets. Since establishing, Polyvalley was given the orientation to the R&D and manufacturing various kinds of high level PC sheets. It owns several independent PC sheet co-extruding production lines with advanced equipments. All of polyvalley PC sheets including hollow flat sheet, solid sheet, structural sheet, click sheet etc. were made by international well known brand raw materials such as GE and Bayer. Polyvalley product sells well not only in all provinces of China but also overseas such as Brail, USA, India, Japan, Russia, Italy etc.

Enterprise development:

Polyvalley is a high technology enterprise with high innovation. It has its special professional R&D department. It takes conventions as self independent innovation and will continually give invest to PC application areas. Till now, Polyvalley has built long term cooperation partnership with several European well know PC sheet manufacturers and will devote themselves to PC R&D and producing.

Our promise:

Upholding the concept of “people oriented, customer first, sustainable business” , Polyvalley will give continual investment on R&D and manufacturing of PC area when developing domestic and oversea market

We promise that Polyvalley will commit to establish long term win-win cooperation relationship with customers or partners based on our in place service and excellent quality.

Polyvalley makes life easier !



Company



Company



Honor

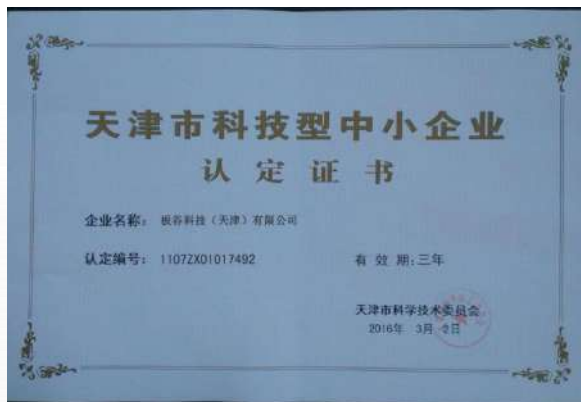

Awarded Small-and-Medium Scientific-and-Technical-Type Enterprises in 2016



Approved Work Safety Standardization in 2015



Approved as Integrity Enterprise in 2013



Awarded high-technology enterprises in 2014

Certificate



中鼎恒昌



Certificate of Approval

Certificate No.: 17918Q10872R0S
Awarded to
Polyvalley Technology (Tianjin) Co., Ltd.
Organization Code Certificate No.: 91120222598707261Y
Add.: No.2 Hengwang Road, Cuihuangkou Town, Wuqing District, Tianjin Zip: 301702

Beijing Zhongding Hengchang Certification Co.,Ltd. (ZDHC) certify that the Quality Management System of the above organization has been assessed and found to be in accordance with the requirements of the standard:
GB/T19001-2016/ISO 9001:2015

SCOPE OF CERTIFICATION/REGISTRATION
Plastics Production and Sales(Except for mandatory regulations); Sales of metal materials

This certificate is used with the requirements of valid laws and regulations which the certification scope involved. These requirements include but are not limited to administrative permits, scopes of qualifications, and CCC requirements etc. In the operating conditions that management system of the certificate holder's conform with the Quality Management System requirements continually, the certificate is valid for three years.

Date from: Mar 3rd, 2018 To: Mar 2nd, 2021
The effectiveness of the Certificate shall be conformed to maintenance by periodic surveillance audit of ZDHC.

The time limit of the certificate is to **Feb 6th, 2019**, please conducting the surveillance or re-certification assessment before **Feb 6th, 2019**.

If the assessment is overdue, the certificate is invalid.

Information of this certificate can be found on the official website of Beijing Zhongding Hengchang Certification Co., Ltd. (<http://www.zdhc.com.cn>)

SCC Accredited
CB-MS
OCSM
Accredited CCN
Certification Body Management System

MEMBER OF MULTILATERAL
IAF
RECOGNITION ARRANGEMENT

Beijing Zhongding Hengchang Certification Co., Ltd.
中鼎恒昌认证有限公司
ISSUED BY
Cao Hongjie

Beijing Zhongding Hengchang Certification Co., Ltd.

Rm.1205, No.2 Building of Guangshun South Street No.16, Chaoyang District, Beijing, P.R. China 100102



中鼎恒昌



Certificate of Environment Management System

Certificate No.: 17918E20470R0S
Awarded to
Polyvalley Technology (Tianjin) Co., Ltd.
Organization Code Certificate No.: 91120222598707261Y
Add.: No.2 Hengwang Road, Cuihuangkou Town, Wuqing District, Tianjin Zip: 301702

Beijing Zhongding Hengchang Certification Co.,Ltd. (ZDHC) certify that the Environment Management System of the above organization has been assessed and found to be in accordance with the requirements of the standard:
GB/T24001-2016/ISO 14001:2015

SCOPE OF CERTIFICATION/REGISTRATION
the environmental management activities involved by Plastics Production and Sales (Except for mandatory regulations); Sales of metal materials and places

This certificate is used with the requirements of valid laws and regulations which the certification scope involved. These requirements include but are not limited to administrative permits, scopes of qualifications, and CCC requirements etc. In the operating conditions that management system of the certificate holder's conform with the Environment Management System requirements continually, the certificate is valid for three years.

Date from: Mar 3rd, 2018 To: Mar 2nd, 2021
The effectiveness of the Certificate shall be conformed to maintenance by periodic surveillance audit of ZDHC.

The time limit of the certificate is to **Feb 6th, 2019**, please conducting the surveillance or re-certification assessment before **Feb 6th, 2019**.

If the assessment is overdue, the certificate is invalid.

Information of this certificate can be found on the official website of Beijing Zhongding Hengchang Certification Co., Ltd. (<http://www.zdhc.com.cn>)

SCC Accredited
CB-MS
OCSM
Accredited CCN
Certification Body Management System

MEMBER OF MULTILATERAL
IAF
RECOGNITION ARRANGEMENT

Beijing Zhongding Hengchang Certification Co., Ltd.
中鼎恒昌认证有限公司
ISSUED BY
Cao Hongjie

Beijing Zhongding Hengchang Certification Co., Ltd.

Rm.1205, No.2 Building of Guangshun South Street No.16, Chaoyang District, Beijing, P.R. China 100102

Philosophy



Customer oriented

Customer oriented is the soul of our corporate culture Polyvalley will always resistant the ideal of customer oriented and take improving quality service and enterprise credit as our long term strategy.



Persevere in innovation

Innovation is premise of our sustained development. We will take the tradition of self innovation and give continual investment on R&D and manufacturing of PC area

Our Facility



Multiwall line

Two wall: 4-12 mm
Four wall: 6-16mm
X wall: 6-16mm
width:2100mm
Capacity: 10T/day



U Panel Line

Four wall: 6-12mm
X wall: 10-20mm
Width:700mm
Capacity: 8T/day



Compact line

Thickness:1.2-20mm
Width:2150mm
Capacity: 12T/day



Corrugated line

Thickness:2mm
Width:1150mm
Capacity: 8T/day

PART 02



Products

Multiwall sheet, U panel, Multiwall corrugated sheet,
Solid corrugated sheet, Multiwall roll sheet



U Panels

Developed by Polyvalley, the U panel has advantages as 100% water proofed, easy-installation, high light transmission, heat insulation, high impact resistance and so on. There is special space between the two panels connection part. So, whole long panels can be used for the large span buildings without worrying about the heat expansion problem. Polyvalley offers the complete set of installing accessories and technique support.

U型结构板 U Panel	厚度 Thickness (mm)	宽度 Width (mm)	K值 K value (W/m ² ·°C)	最小弯曲半径 Bending radius (m)
	6mm	700	2.65	4.20
	8mm		2.57	4.60
	10mm		2.40	5.00
	12mm		2.22	5.40
	14mm	700	2.10	5.80
	16mm		2.00	6.20
	18mm		1.85	6.60
	20mm		1.80	6.80

Polyvalley can make any colors (clear, ICE, opal, blue, green, smoke, bronze ETC.) as customer requirement. The surface or both sides can be done as anti-UV, IR, or anti-glare.

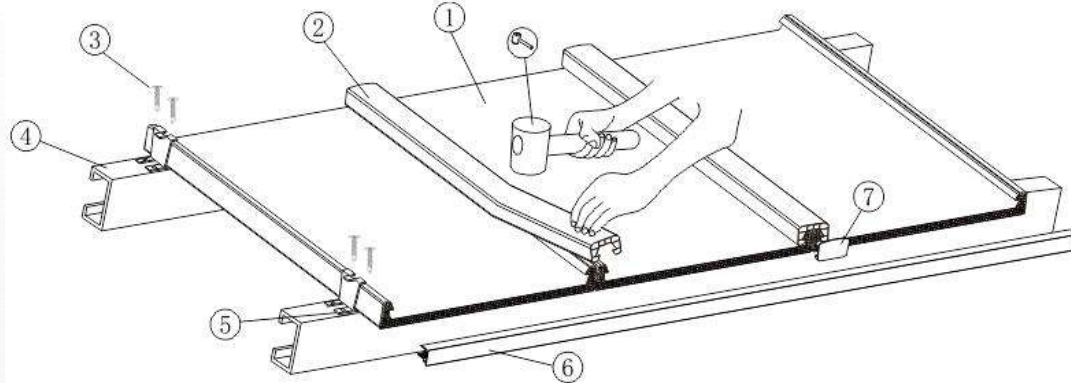

U Panels

Roofing installation



1, 安装第一块结构板
Install the first U-system panel



2, 安装不锈钢紧固件
Install the stainless fixer



3, 安装第二块结构板
Install the second U-system panel



5, 用橡皮锤把扣条锤紧
Fix the PC cover gasket by a hammer



4, 安装PC或者铝合金扣条
Install the PC or AL gasket cover



6, 安装堵头及收边条
Install the stoper and end cap

U panel for cladding

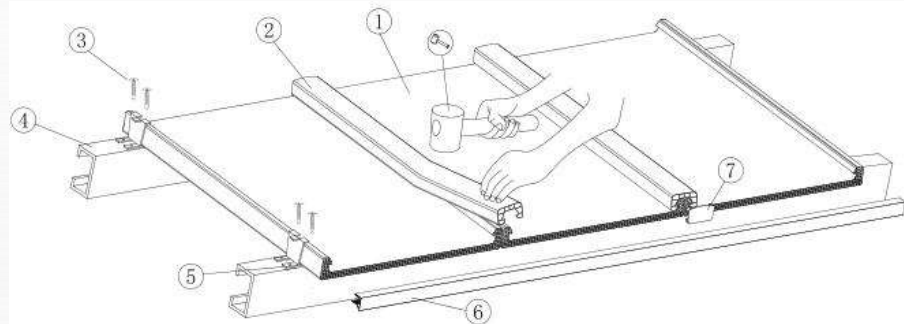
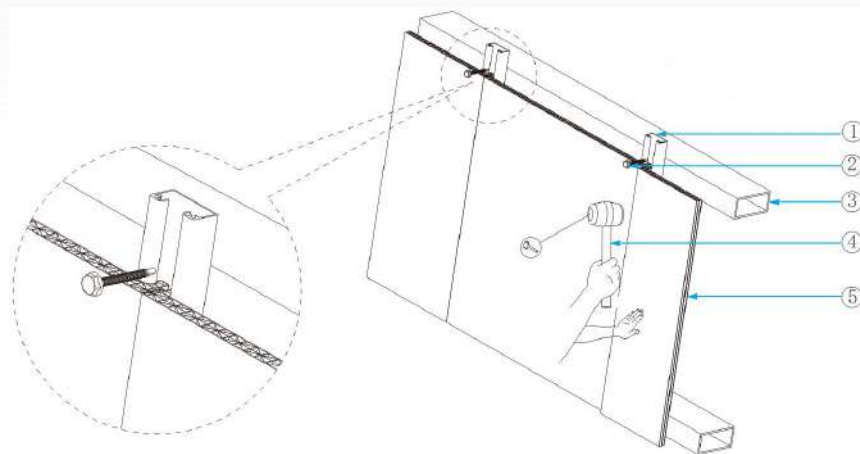

- ① 板谷U型结构板 U Panel
- ② PC或者铝合金扣条 PC or AL Cover (#302 #303)
- ③ 专用紧固件螺丝 Screw (#305)
- ④ 檩条, 骨架 Purlin
- ⑤ 不锈钢紧固件 Stainless Fastener(#304)
- ⑥ 铝合金或者PC收边条 (#301 #308 #309)
- ⑦ 堵头 End cap (#311 #312)
- ⑧ 橡皮锤 Hammer

- ① 铝合金扣条 AL connector (#303)
- ② 专用螺丝 Screw (#307)
- ③ 墙面檩条 Purlin
- ④ 橡皮锤 Hammer
- ⑤ U型结构板 U Panel

U Panels

U Panel Roofing installation



U panel for cladding



Multiwall Corrugated

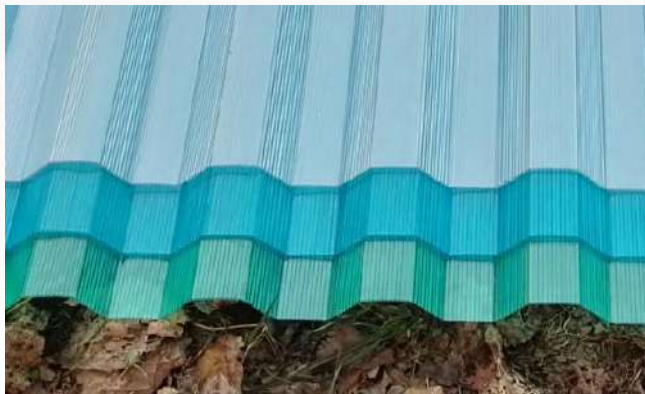

Greca 1100M-26/112

width: 1100mm (effective 1050mm)
Wave height: 26mm; Pitch: 112mm



Corrugated 1080M-28/203

width: 1080mm (effective 1010mm)
Wave height: 28mm; Pitch: 203mm



Corrugated 1110M-28/210

width: 1110mm (effective 1050mm)
Wave height: 28mm; Pitch: 210mm

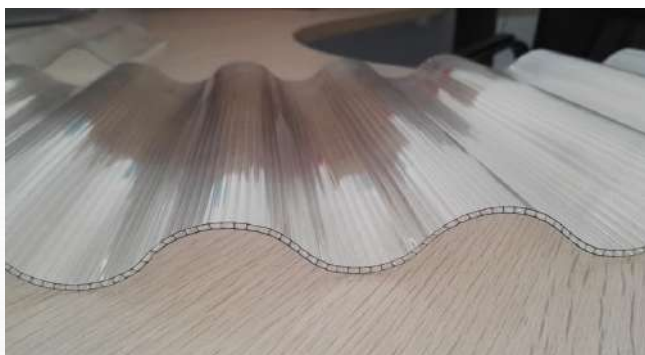

Corrugated 1190M-18/76

width: 1190mm (effective 1114mm)
Wave height: 18mm; Pitch: 76mm



Corrugated 920M-57/177

width: 920mm (effective 873mm)
Wave height: 57mm; Pitch: 177mm

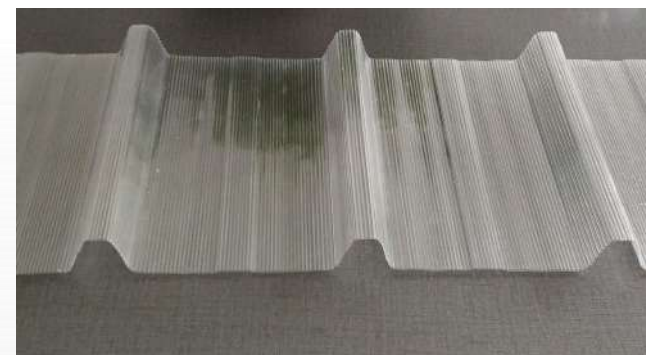

Corrugated 920M-38/218

width: 920mm (effective 875mm)
Wave height: 38mm; Pitch: 218mm

Solid Corrugated



Greca 1100S-26/112

width: 1100mm (effective 1050mm)
Wave height: 26mm; Pitch: 112mm

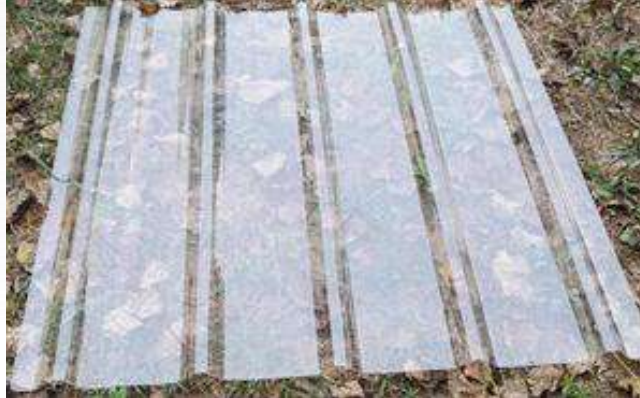

Corrugated 1080S-28/203

width: 1080mm (effective 1010mm)
Wave height: 28mm; Pitch: 203mm



Corrugated 1110S-28/210

width: 1110mm (effective 1050mm)
Wave height: 28mm; Pitch: 210mm

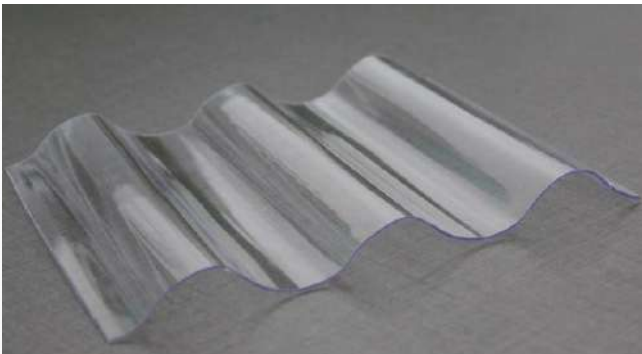

Corrugated 1190S-18/76

width: 1190mm (effective 1114mm)
Wave height: 18mm; Pitch: 76mm



Corrugated 920S-57/177

width: 920mm (effective 873mm)
Wave height: 57mm; Pitch: 177mm



Corrugated 920S-38/218

width: 920mm (effective 875mm)
Wave height: 38mm; Pitch: 218mm

Roll sheet



Developed by Polyvalley, the waved sheet is a new polycarbonate sheet with advantages as high light transmit, easy-shaped, heat isolation, high load impact etc. The waved sheet have very small bending radius, thus can be rolling packed. It is very suitable for skylight, carport, greenhouse and so on.

- Very small bending radius, can be rolling packed, suitable for transportation.
- Small Expansion and Contraction, it can be made as longer as required.
- Very high impact resistance: With waved structure, its load and strength is as 2 or 3 times high as normal flat sheet.

Roll sheet

板谷中空条纹板结构图及基本参数 Basic Specification

板材Sheet	厚度thickness (mm)	宽度width (mm)	传热系数W/M ² °C	最小弯曲半径bending (mm)	透光率 % LT
条纹板 Waved sheet	2.0	2100 or 1220	4.2	400	85

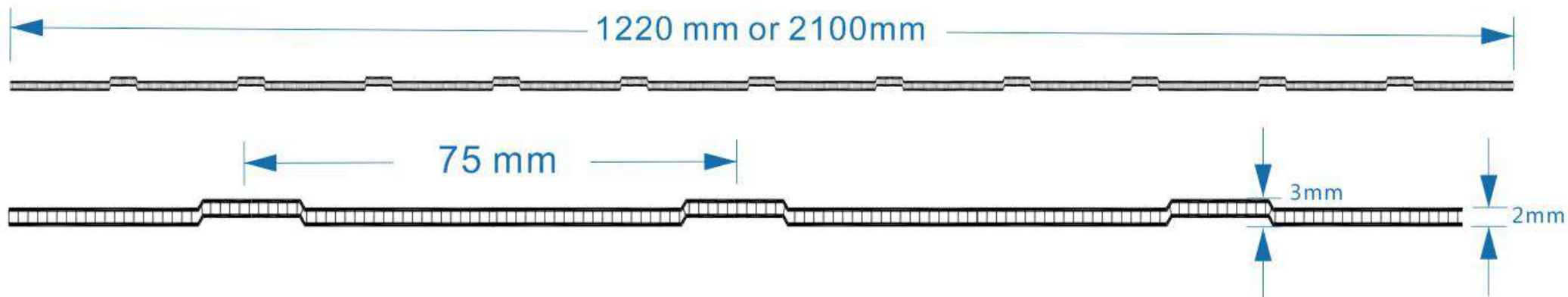

Multiwall

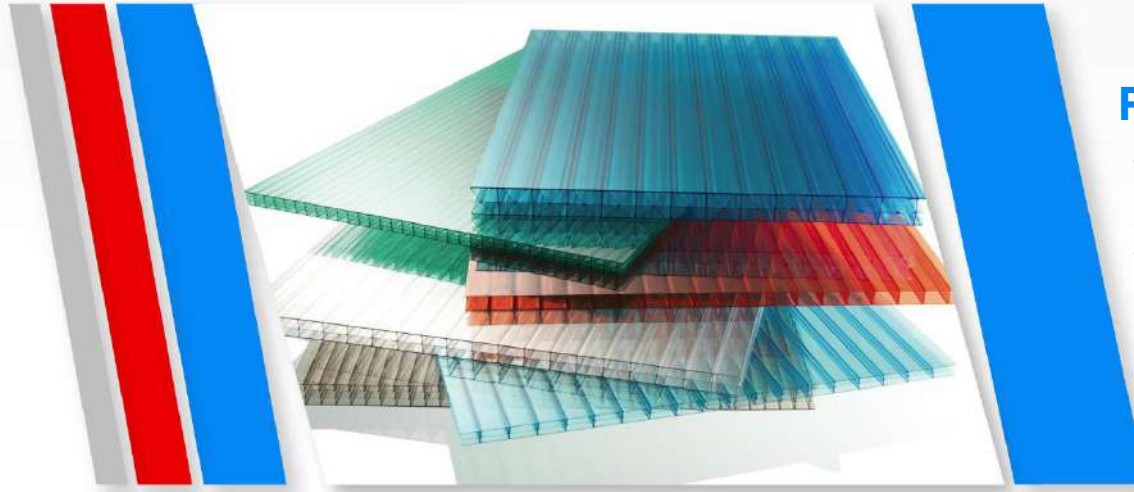

Four and X wall

Thickness:6-16mm

Length: no limited

Width: within 2100mm

Color: Clear, white, blue Green, bronze etc.

Two wall sheets

Thickness from 4 to 12mm

length: no limited



Width: within2100mm

Color: Clear, white, blue, green, bronze etc.

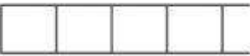
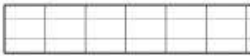
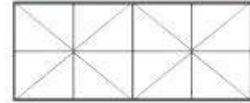

Multiwall

Multiwall sheet specifications:

板材结构 Structure	产品代码 Model	厚度Thick (mm)	宽度Width (mm)	克重Weight (kg/m ²)	UV涂层 UV side	标准K值 K-Value w/m ² *k	透光率(%) LT		最小弯曲半径 (mm) Minimum bend radius	声音降低值(db) Sound reduction
							透明clear	乳白opal		
口字二层结构 2-wall R-structure 	BGF24R	4	2100	0.85	50μ	3.96	80	47	700	15
	BGF26R	6		1.30	50μ	3.56	78	46	1050	17
	BG28R	8		1.50	50μ	3.26	76	44	1400	18
	BGF210R	10		1.70	50μ	3.02	73	44	1750	19
	BGF212R	12		1.90	50μ	2.78	72	42	2100	20
矩形四层结构 4-wall R-structure 	BGF46R	6	2100	1.30	50μ	2.56	71	42	1400	18
	BGF48R	8		1.50	50μ	2.56	71	42	1400	18
	BGF410R	10		1.70	50μ	2.39	71	41	1750	19
	BGF412R	12		1.90	50μ	2.30	70	41	2100	20
	BGF414R	14		2.30	50μ	2.10	69	40	2450	21
	BGF416R	16		2.70	50μ	2.00	68	38	2800	22
五层米子结构 5-wall X-structure 	BGF56R	6	2100	1.30	50μ	2.56	71	42	1400	18
	BGF58R	8		1.50	50μ	2.56	71	42	1400	18
	BGF510R	10		1.70	50μ	2.39	71	41	1750	19
	BGF512R	12		1.90	50μ	2.30	70	41	2100	20
	BGF514R	14		2.30	50μ	2.10	69	40	2450	21
	BGF516R	16		2.70	50μ	2.00	68	38	2800	22
七层双米子结构 7-wall X-structure 	BGF722D	22	2100	3.40	50μ	1.51	58	35	3850	22
	BGF725D	25		3.60	50μ	1.41	57	34	4375	23
	BGF732D	32		4.00	50μ	1.32	53	28	5600	23
	BGF735D	35		4.50	50μ	1.19	50	27	6125	24
	BGF740D	40		5.00	50μ	1.19	50	27	6125	24

Multiwall

采用PC H 中接安装方法
Install with PC H connector

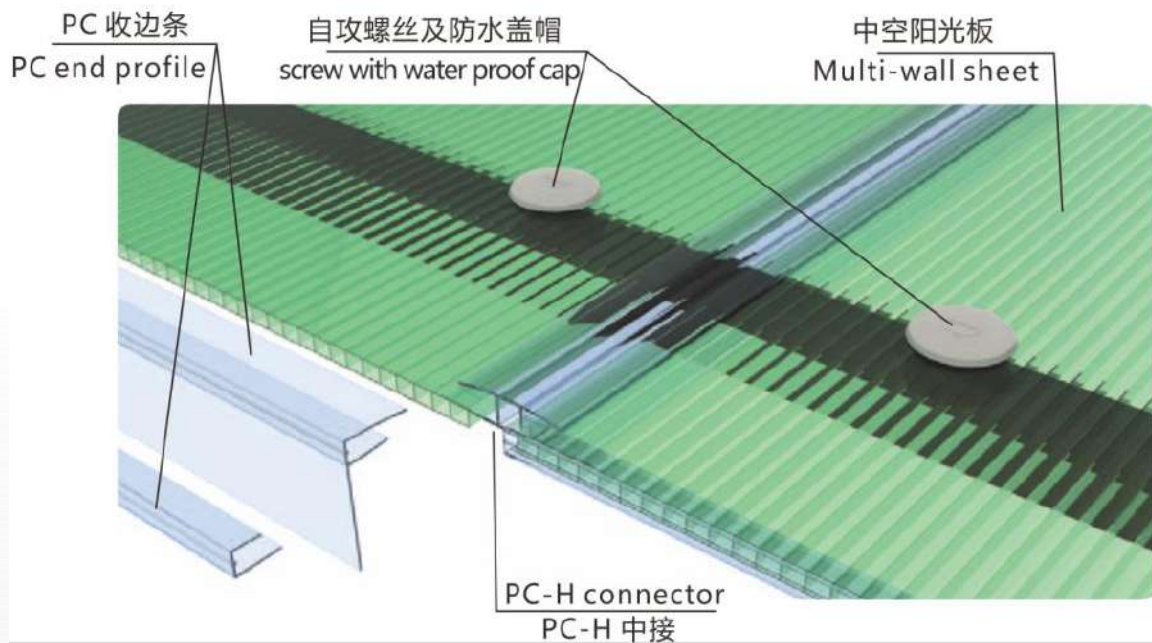

采用铝合金压上下扣安装方法
Install with AL double Bar

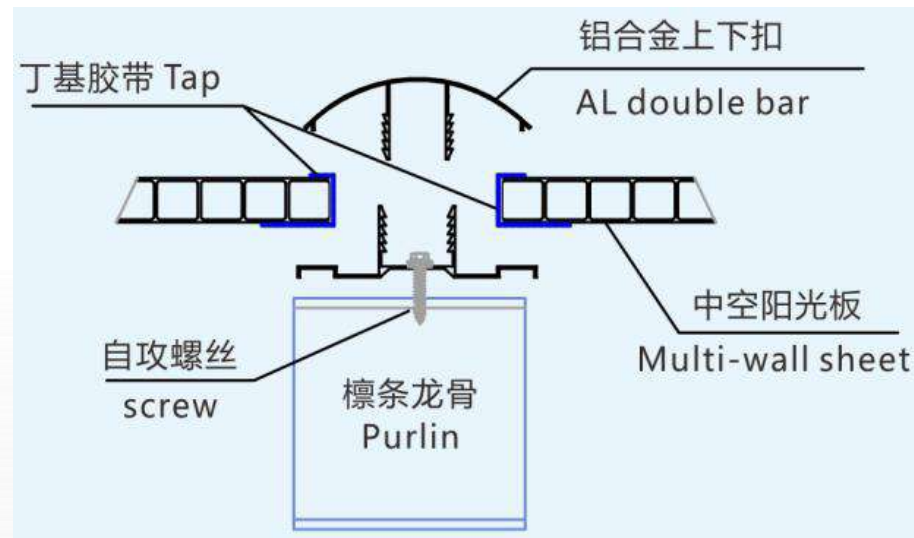

Multiwall



Solid sheet



General Solid

Thickness:1.2-20mm

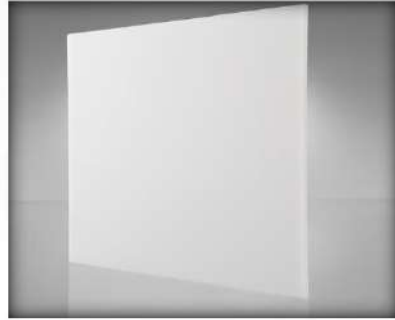

Diffusion sheet

For LED sepacil



Embossed sheet

Diamond sheet, suitable for decoration



Frosted sheet

Frosted sheet



Anti-static

For machine, screen etc.
For machine, screen etc.

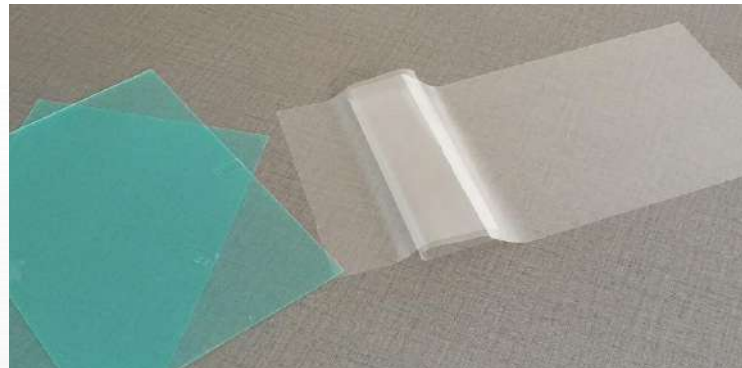

Ultra thin

Thickness: 0.025-0.85
For medical equipment special



Solid U Panel

Thickness: 1.8-12mm

Main project



Swimming pool

Polyvalley 20mm U panel
9000 SMQ

ADD: Linyi Shandong China

Main project



Flour Mill

Polyvalley 16mm U panel
2800 SMQ

ADD: Tangshan Hebei China

Main project



Spherical Greenhouse

Polyvalley 10mm U panel
13000 SMQ

ADD: Taigu Shanxi China

Main project



Office Building

Polyvalley 20mm U panel
1200 SMQ

ADD: Beijing China

Main project



Green house

Polyvalley 10mm multiwall
12000 SMQ

ADD: Shanxi China

Main project

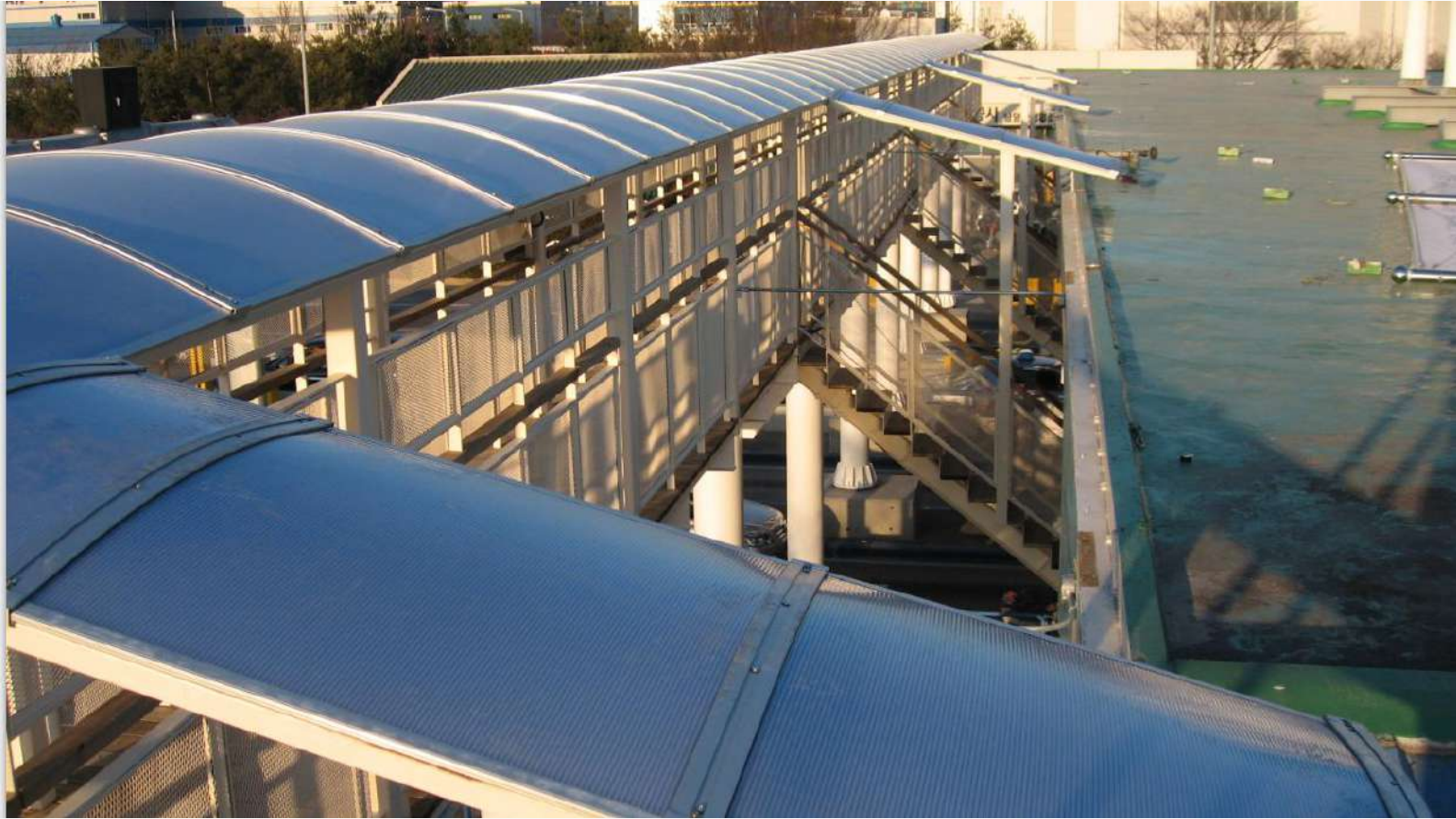

Pedestrian bridge

Polyvalley 10mm multiwall
1000 SMQ

ADD: Heilongjiang China

Main project



U panel roofing

Polyvalley 10mm U panel
1500 SMQ

ADD: Shandong China

Main project



U panel roofing

Polyvalley 10mm U panel
1500 SMQ

ADD: Shandong China

Our Service



Pre-Sales

We have professional sales which can speak foreign languages such as English, Spanish, Japanese etc. You are always welcomed to inquiry from us at any time



Free design service

We have designers and technicians who can offer you the professional service free of charges



After sales service

Special after sales team offer 7X24 service.
7X24 services with the fastest response for any after sales service

THANKS

谢谢观看

Headquarters ADD: No.2 Hongwang Road Polyvalley Technology Park, Wuqing Tianjin, China

TEL: (+86)-22-5967-2888 FAX: (+86)-22-5967-3666

Hotline: (+86)400 086 3628

Email: sales@polyvalley.com.cn

website: www.polyvalley.com